

The background of the page is a technical drawing of a door profile, overlaid with a white grid. A metal caliper is shown measuring a part of the profile. Various technical specifications are visible, including "Ra 1.6", "Ra 0.8", "2.5x45°", "d-8x32H7x38H12x6D9", "CSN 01 4942", and "3x45°".

TECHNICAL DATA SHEET FOR DSA STEEL DOORS

SPECIFICATIONS

Resistance to fire:
E30, EI₂30, EW30

Smoke resistance:
S_a, S₂₀₀

Self-closing durability:
C5

Sound insulation:

R_w 32 dB

Thermal transmittance:
1,5 W/(m²·K)



“DSA LIGHT” DOOR DIMENSIONS

DIMENSIONS IN RANGE FROM TO
 (according to certificate)

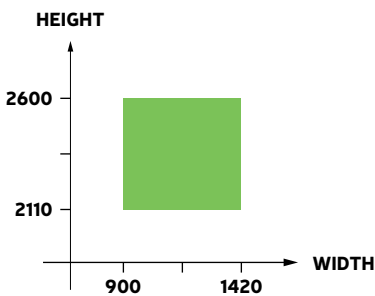

Smoke and Fire

“DSA LIGHT” DOOR CROSS SECTION

CROSS-CUT WITH C FRAME

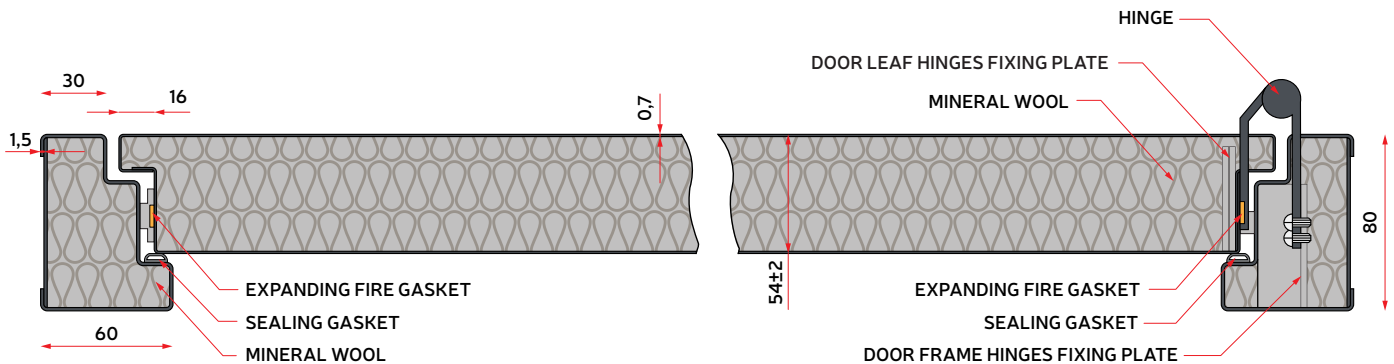

"DSA LIGHT" DOOR FRAME TYPES

DOOR FRAME – DSA C

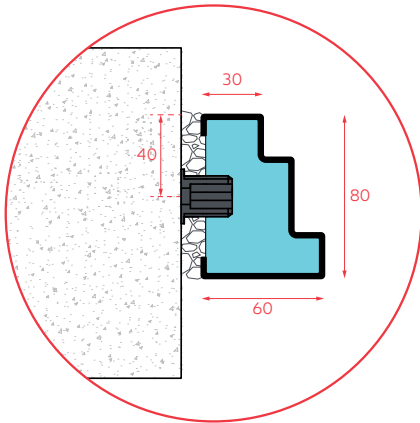

DOOR FRAME - B

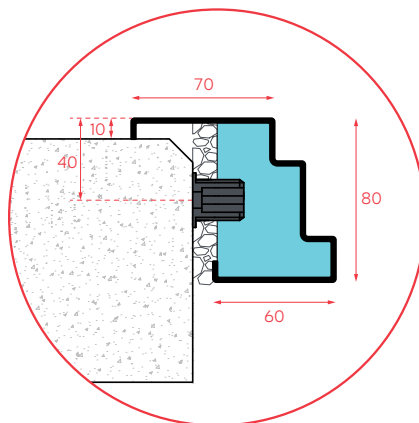

DOOR FRAME B WITH SUB-FRAME

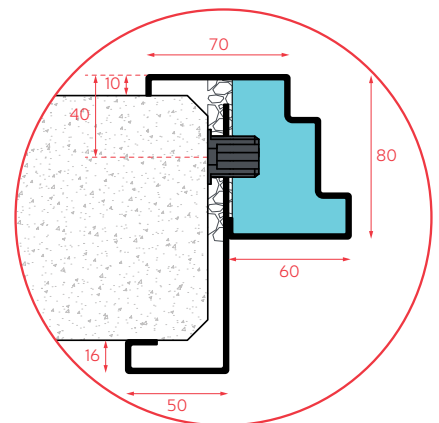

"DSA LIGHT" THRESHOLDS

LN 8/20



LN 12/25

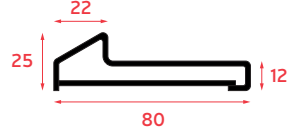

L12/25 *

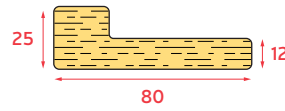

L20/35 *

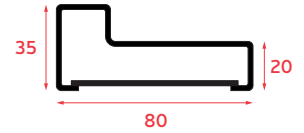

L30/45 *

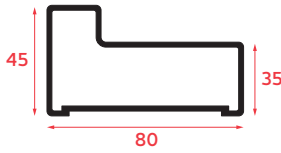

L40/55 *

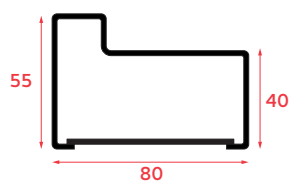

I4 **



Mechanical Threshold **

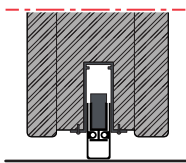

Slaplist **

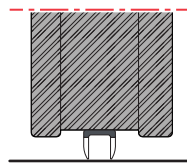

* This type of threshold may be produced from steel or hardwood.

** This type of threshold is fireproof, smoke only S_a

SPECIFICATIONS

Sound insulation:

R_w 32 dB

Thermal transmittance:

1,5 W/(m²·K)

“DSA LIGHT” DOOR DIMENSIONS

DIMENSIONS FOR SINGLE LEAF DOOR

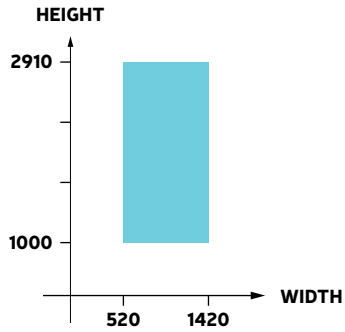

● Maximum production dimensions

DIMENSIONS FOR DOUBLE LEAF DOOR

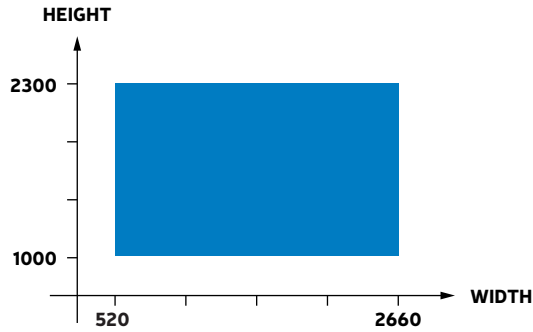

● Maximum production dimensions

“DSA LIGHT” DOOR CROSS SECTION

SINGLE LEAF DOOR CROSS-CUT WITH C FRAME

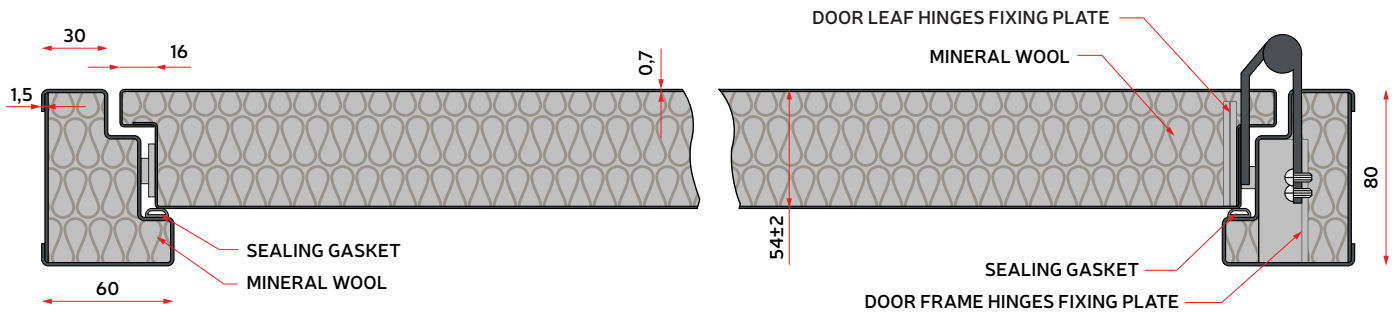

DOUBLE LEAF DOOR CROSS-CUT WITH C FRAME

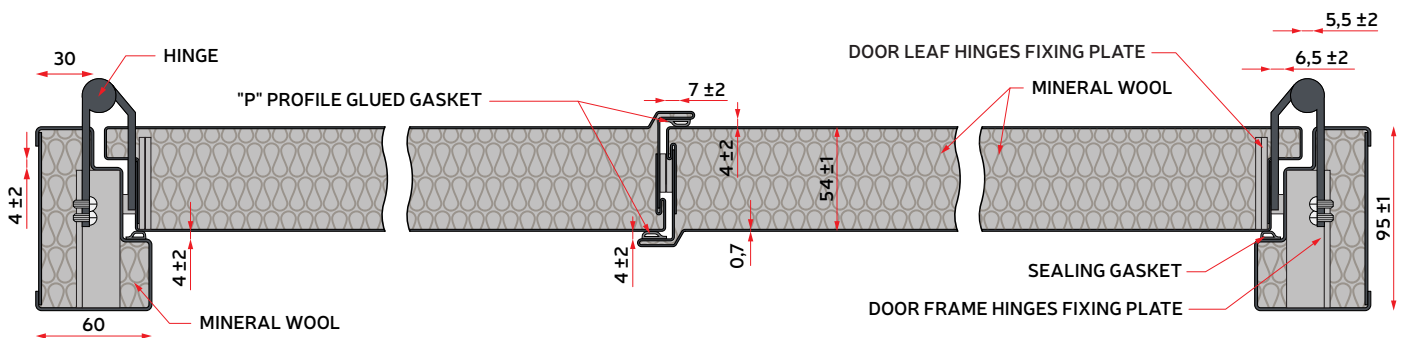

“DSA LIGHT” DOOR FRAME TYPES

DOOR FRAME – DSA C

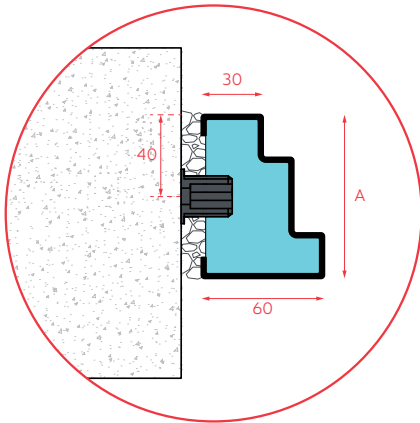

DOOR FRAME - B

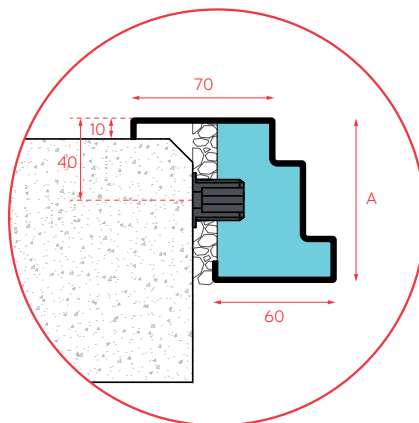

DOOR FRAME B WITH SUB-FRAME

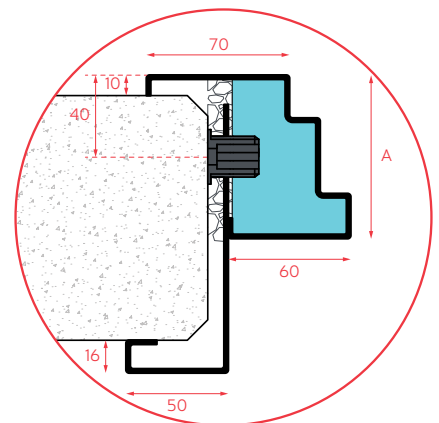

Dimension “A” for single leaf door – 80 mm; for double leaf door – 95 mm

“DSA LIGHT” THRESHOLDS

LN 8/20

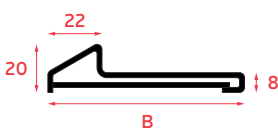

LN 12/25

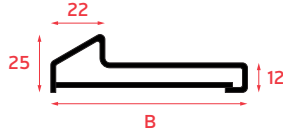

L12/25 *

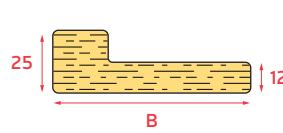

L20/35 *

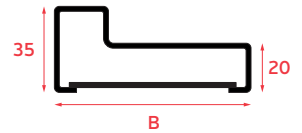

L30/45 *

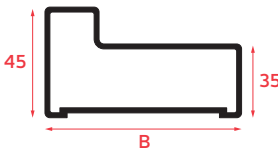

L40/55 *

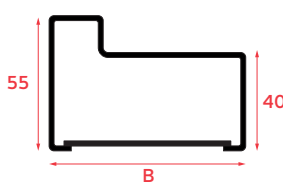

I4



Mechanical Threshold

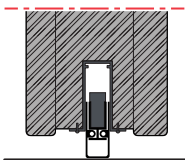

Slaplist

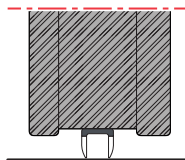

Dimension “B” for single leaf door – 80 mm; for double leaf door – 95 mm

* This type of threshold may be produced from steel or hardwood.

SPECIFICATIONS

Resistance to fire:
E30, EI₂30, EW30

Smoke resistance:

S_a, S₂₀₀

Self-closing durability:

C5

Sound insulation:

R_w 41 / 44 / 45 dB

Thermal transmittance:

1,3 / 1,5 W/(m²·K)

Burglary resistance:

RC2 (Lock ASSA 310)

RC3 (Locks ASSA 510 and FIX510 / ASSA 310+Mottura 40705)

WATER/AIR/WIND:

Watertightness: **cl. 5A**

Air permeability: **cl. 3**

Resistance to wind load: **cl. C4**

“DSA3” DOOR DIMENSIONS

DIMENSIONS IN RANGE FROM TO
 (according to certificate)

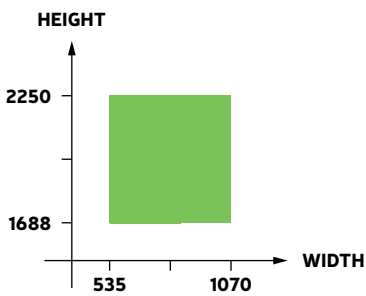

 Smoke and Fire

“DSA3” DOOR CROSS SECTION

CROSS-CUT WITH C FRAME

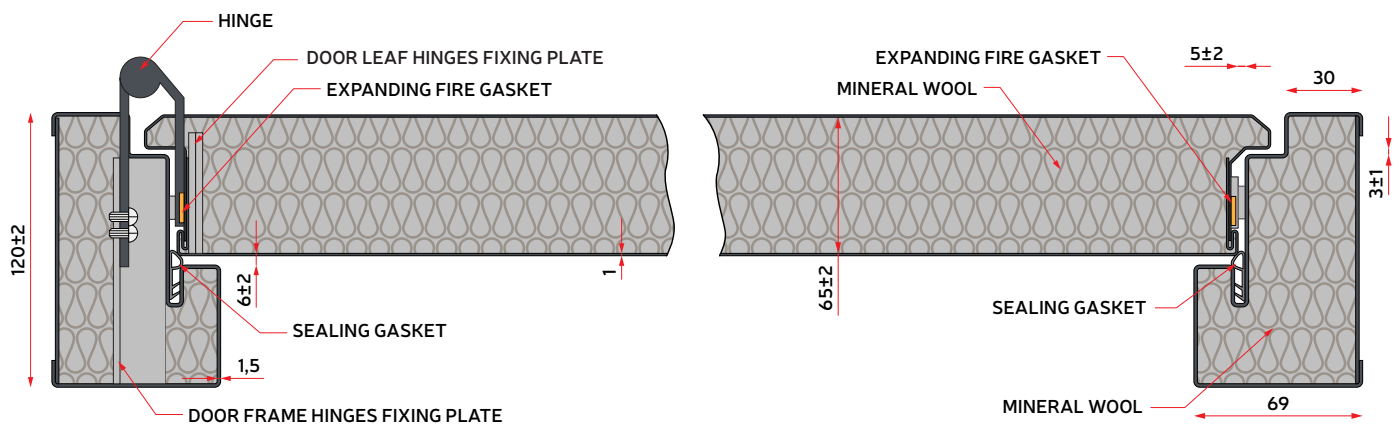

“DSA3” DOOR FRAME TYPES

DOOR FRAME – DSA C

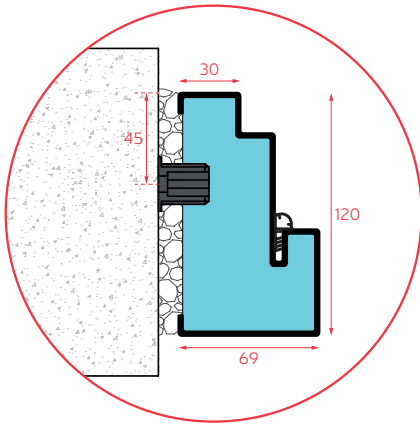

DOOR FRAME – DSA C15

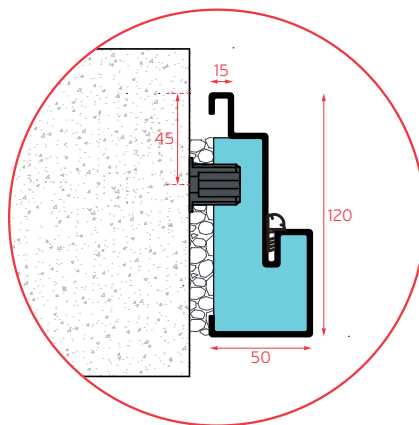

DOOR FRAME - B

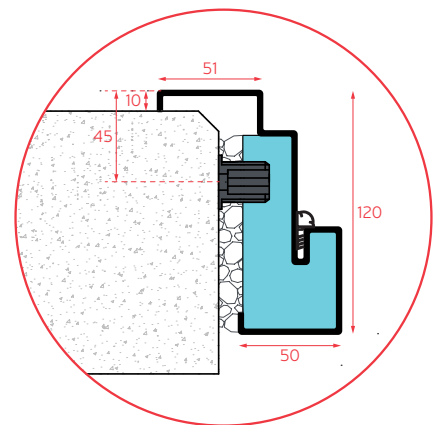

DOOR FRAME B WITH SUB-FRAME

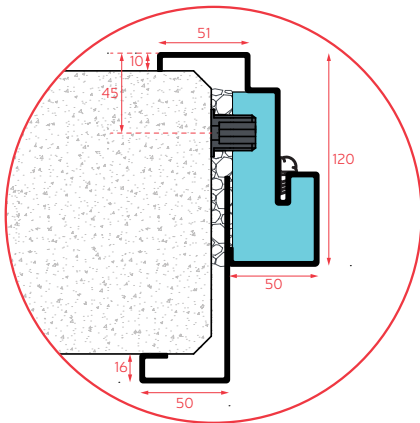

“DSA3” THRESHOLDS

LN 8/20

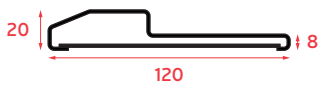

LN 12/25 *

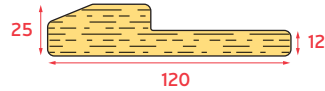

L12/25 *

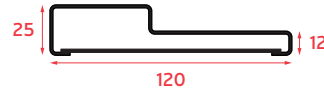

L20/35 *

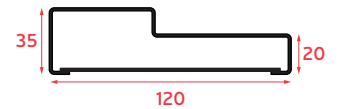

L30/45 *

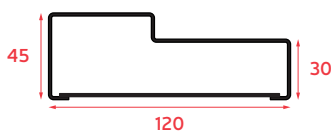

L40/55 *

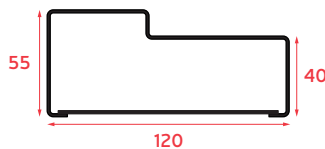

L5/20



I4 **



Mechanical Threshold **

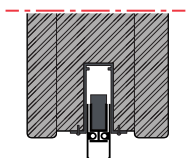

Slaplist **

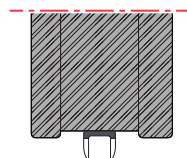

* This type of threshold may be produced from steel or hardwood.

** This type of threshold is fireproof, smoke only S_a

SPECIFICATIONS

Sound insulation:
 R_w 41 / 44 / 45 dB
 Thermal transmittance:
1,3 / 1,5 W/(m²·K)
 Burglary resistance:
RC2 (Lock ASSA 310)

RC3 (Locks ASSA 510 and FIX510 / ASSA 310+Mottura 40705)
 WATER/AIR/WIND:
 Watertightness: **class 5A**
 Air permeability: **class 3**
 Resistance to wind load: **class C4**

“DSA3” DOOR DIMENSIONS

DIMENSIONS FOR SINGLE LEAF DOOR

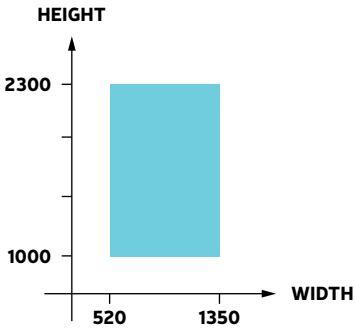

DIMENSIONS FOR DOUBLE LEAF DOOR

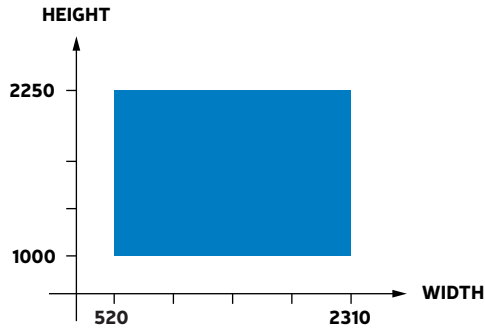

● Maximum production dimensions

● Maximum production dimensions

“DSA3” DOOR CROSS SECTION

SINGLE LEAF DOOR CROSS-CUT WITH C FRAME

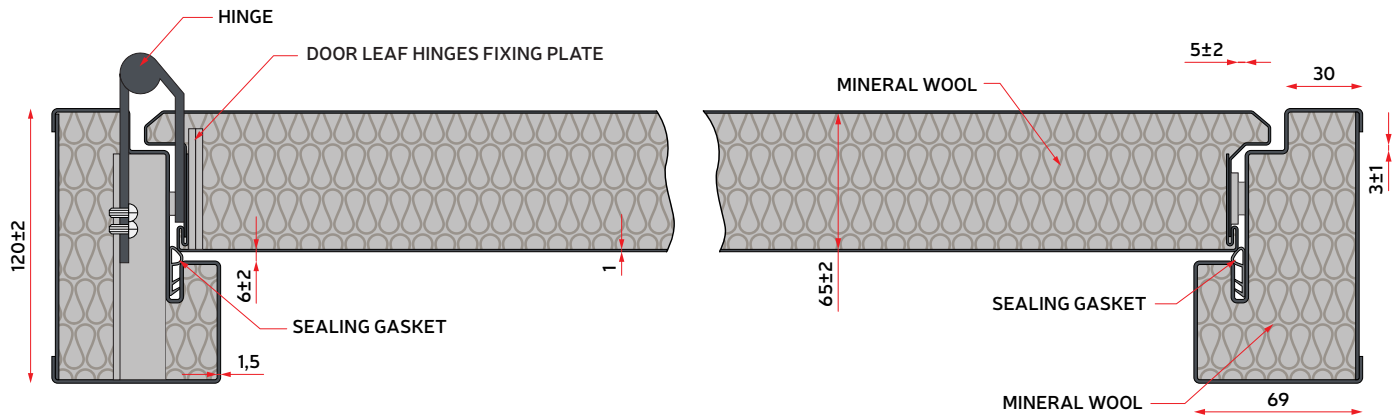

DOUBLE LEAF DOOR CROSS-CUT WITH C FRAME

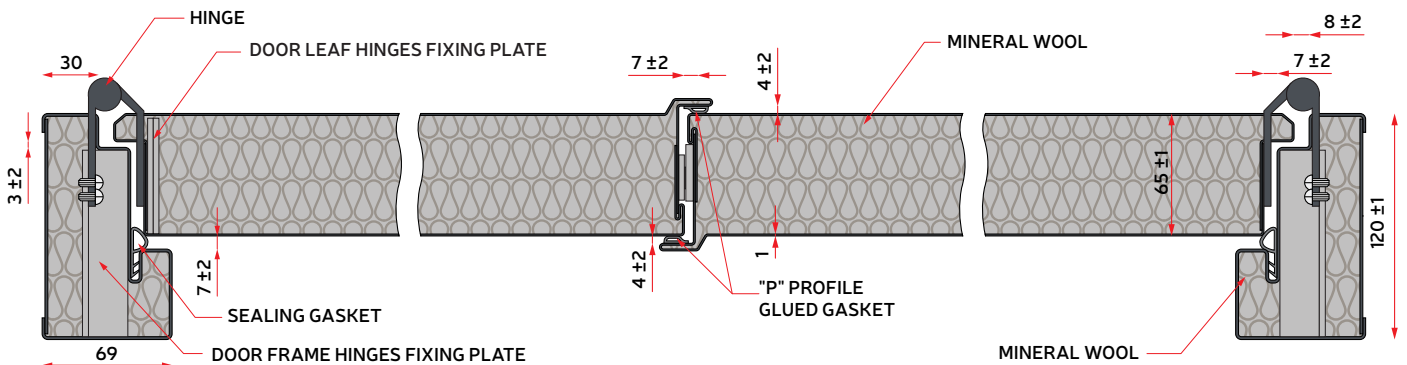

“DSA3” DOOR FRAME TYPES

DOOR FRAME – DSA C

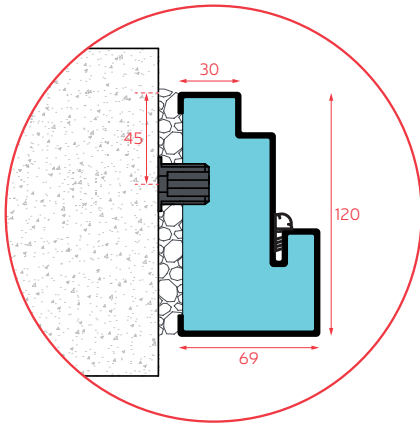

DOOR FRAME – DSA C15

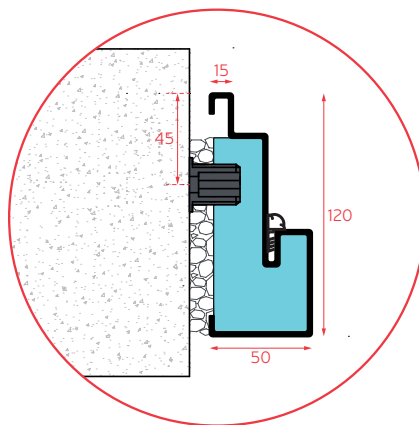

DOOR FRAME - B

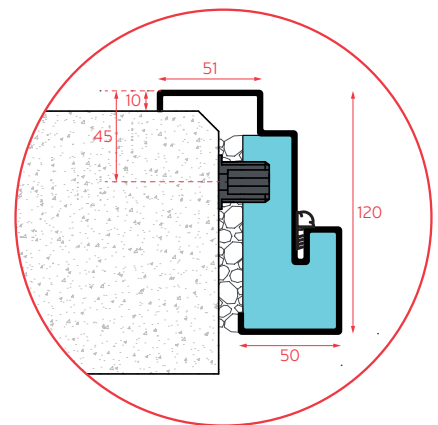

DOOR FRAME B WITH SUB-FRAME

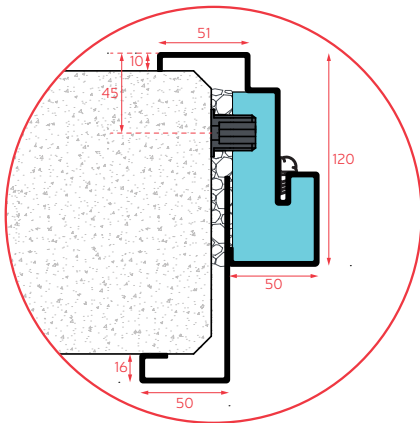

“DSA3” THRESHOLDS

LN 8/20

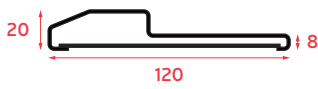

LN 12/25 *

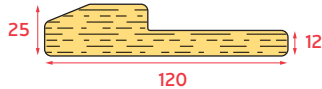

L12/25 *

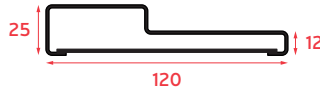

L20/35 *



L30/45 *

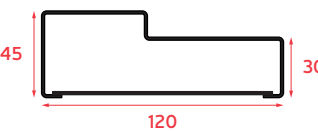

L40/55 *



L5/20

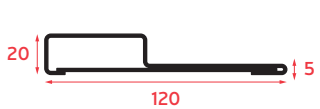

I4



Mechanical Threshold

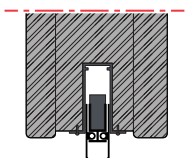

Slaplist

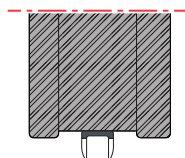

* This type of threshold may be produced from steel or hardwood.

SPECIFICATIONS

Resistance to fire:
E60, EI₂60, EW60

Smoke resistance:

S_a, S₂₀₀

Self-closing durability:

C5

Thermal transmittance:

1,6 W/(m²·K)

Burglary resistance:

RC3 (Locks ASSA 510 and FIX510)



“DSA6” AND “DSA6 GL” DOOR DIMENSIONS

“DSA6” DIMENSIONS IN RANGE FROM TO (according to certificate)

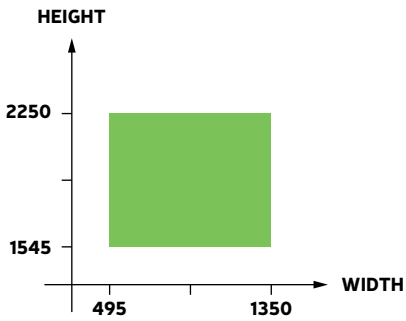

● Smoke and Fire

“DSA6” DOOR CROSS SECTION

“DSA6” DOOR CROSS-CUT WITH C FRAME

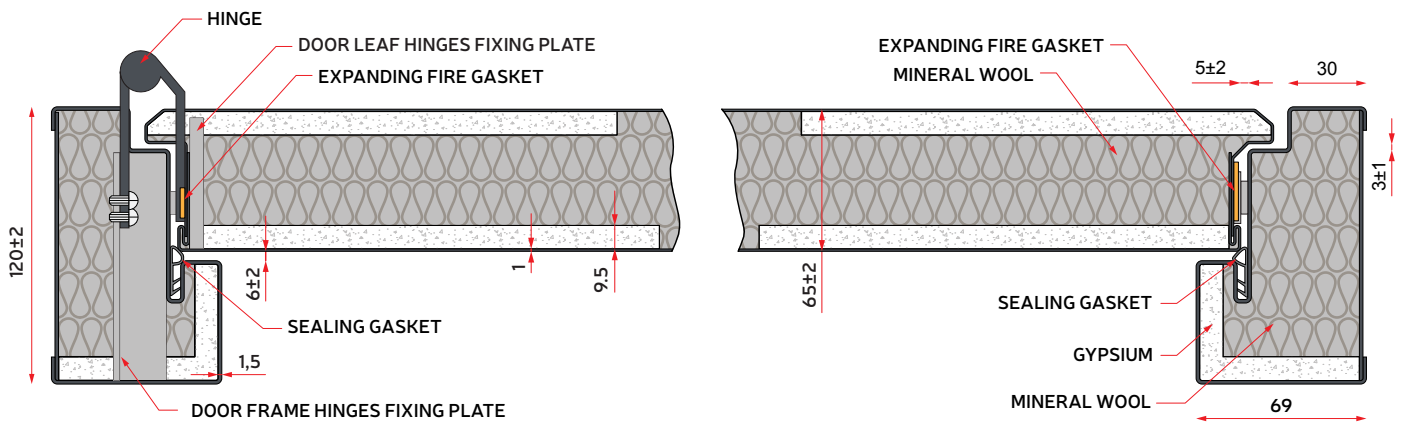

“DSA6” DOOR FRAME TYPES

DOOR FRAME – DSA C

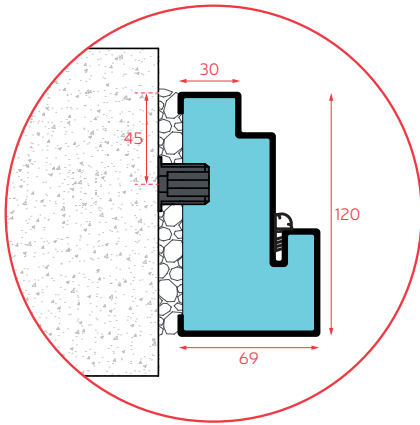

DOOR FRAME – DSA C15

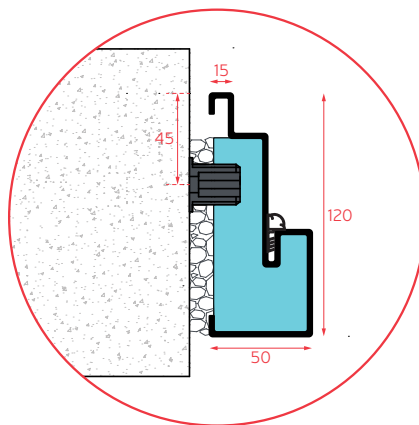

DOOR FRAME - B

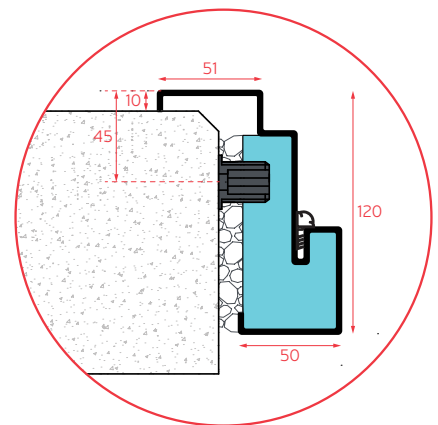

DOOR FRAME B WITH SUB-FRAME

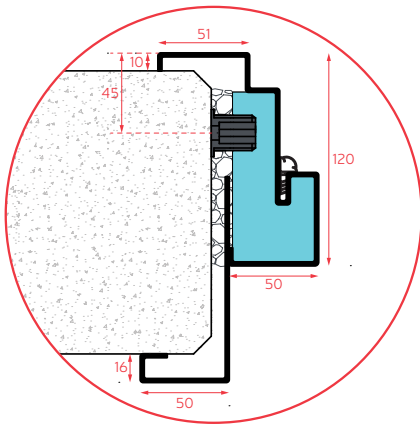

“DSA6” THRESHOLDS

LN 8/20



LN 12/25 *

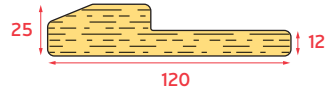

L12/25 *

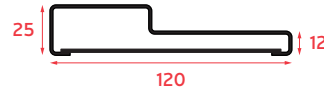

L20/35 *

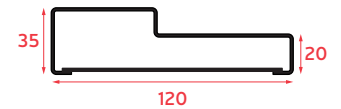

L30/45 *

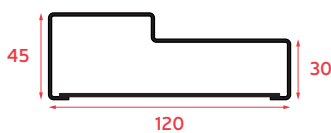

L40/55 *

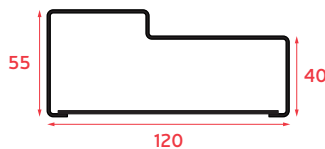

L5/20



I4 **



Mechanical Threshold **

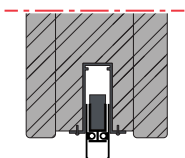

Slaplist **

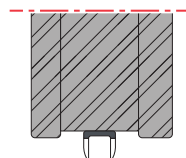

* This type of threshold may be produced from steel or hardwood.

** This type of threshold is fireproof, smoke only S_a

SPECIFICATIONS

Resistance to fire:
E60, EI₂60, EW60

Smoke resistance:
S_a, S₂₀₀

Self-closing durability:
C5

Sound insulation:

R_w 41 dB

Thermal transmittance:
2,1 W/(m²·K)

WATER/AIR/WIND:

Watertightness: **class 4A**

Air permeability: **class 4**

Resistance to wind load: **class C5**

“DSA6 GL” DOOR DIMENSIONS

“DSA6 GL” DIMENSIONS IN RANGE FROM TO (according to certificate)

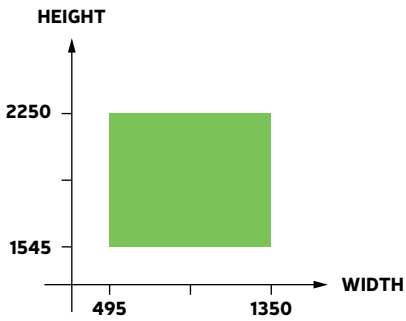

GLASSES

Fireblock60 25 mm (630x1030) – smoke and fire

Tempered glass 6 mm (630x1030) – only smoke

The dimensions of the glasses are not larger than 0.6 m² (EI60)

 Smoke and Fire

“DSA6 GL” DOOR CROSS SECTION

“DSA6 GL” DOOR CROSS-CUT WITH C FRAME

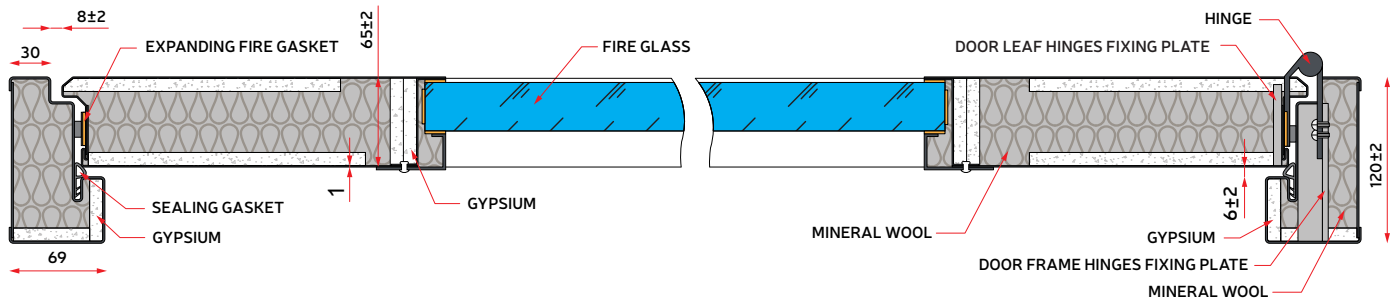

“DSA6 GL” DOOR FRAME TYPES

DOOR FRAME – DSA C

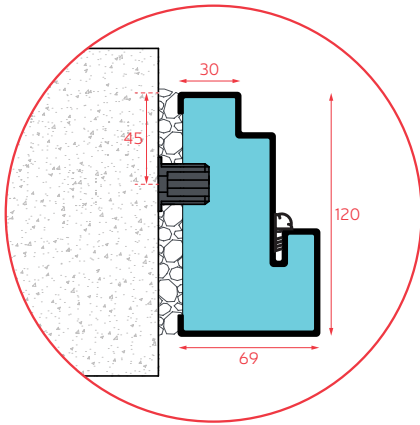

DOOR FRAME – DSA C15

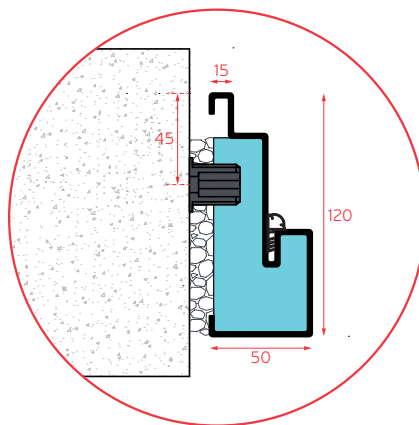

DOOR FRAME - B

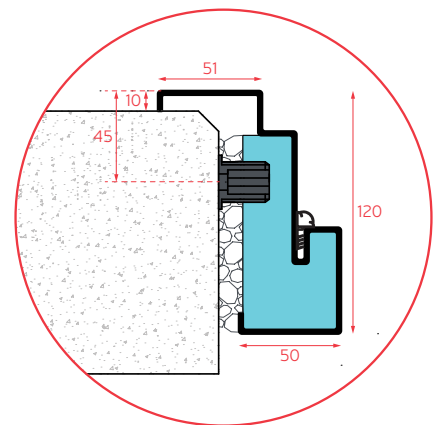

DOOR FRAME B WITH SUB-FRAME

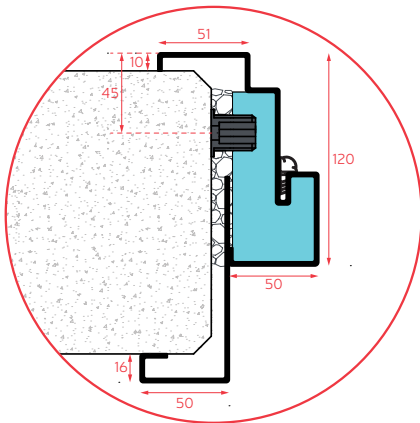

“DSA6 GL” THRESHOLDS

LN 8/20

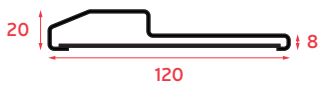

LN 12/25 *

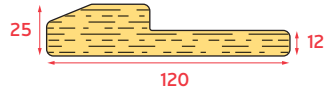

L12/25 *

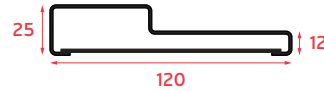

L20/35 *

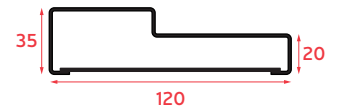

L30/45 *

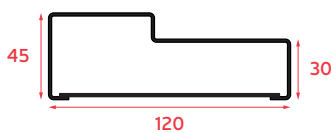

L40/55 *

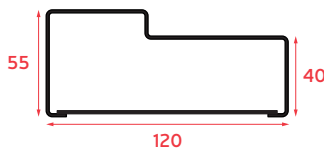

L5/20



I4 **



Mechanical Threshold **

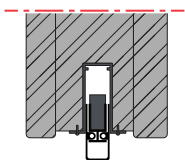

Slaplist **

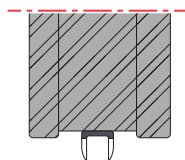

* This type of threshold may be produced from steel or hardwood.

** This type of threshold is fireproof, smoke only S_a

SPECIFICATIONS

Resistance to fire:

E60, EI₂60, EW60

Smoke resistance:

S_a, S₂₀₀

Self-closing durability:

C5



“DSA6 MAX” DOOR DIMENSIONS

DIMENSIONS IN RANGE FROM TO
(according to certificate)

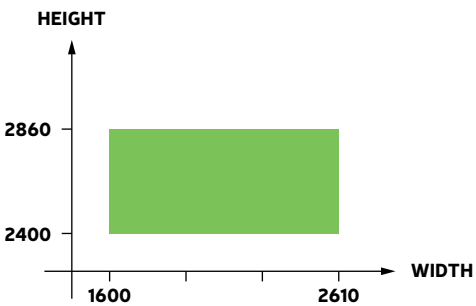

● Smoke and Fire

GLASSES

Fireblock60 25 mm (630x1030) – smoke and fire

Polflam EI60 28 mm (630x1030) – smoke and fire

The dimensions of the glasses are not larger than 0.6 m²

“DSA6 MAX” DOOR CROSS SECTION

“DSA6 MAX” CROSS-CUT WITH C FRAME

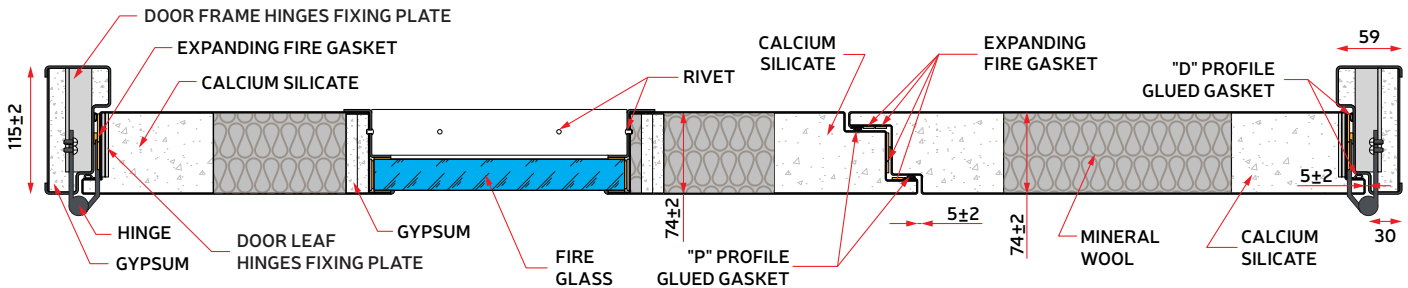

“DSA6 MAX” DOOR FRAME TYPES

DOOR FRAME – DSA C

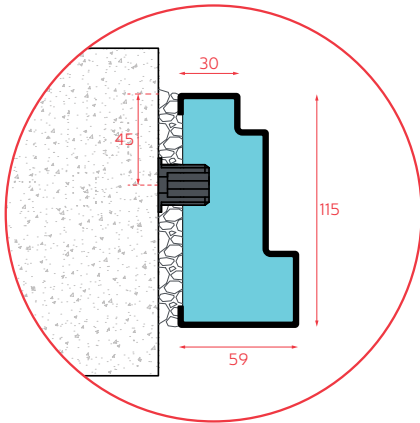

DOOR FRAME - B

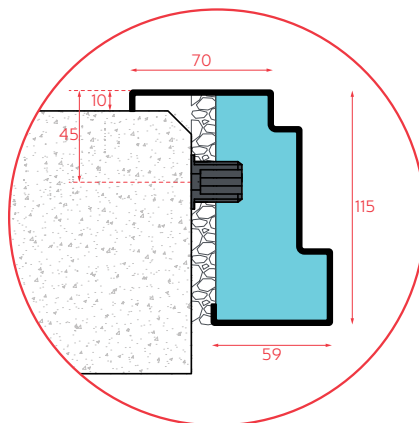

DOOR FRAME B WITH SUB-FRAME

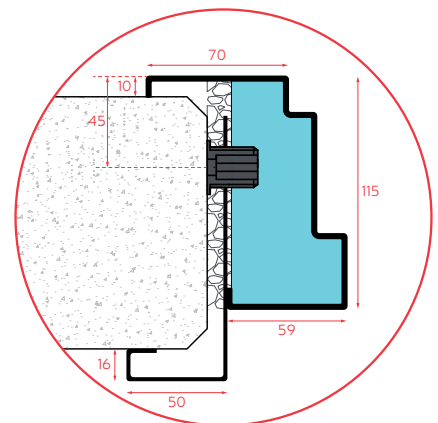

“DSA6 MAX” THRESHOLDS

LN 8/20



LN 12/25 *

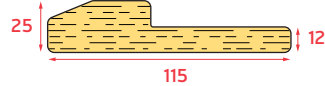

L12/25 *



L20/35 *



L30/45 *

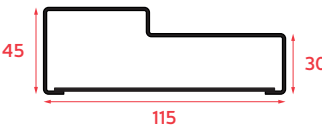

L40/55 *

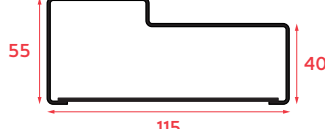

L5/20

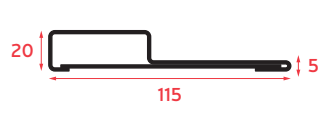

I4 **

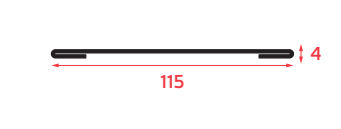

Mechanical Threshold **

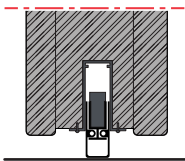

Slaplist **

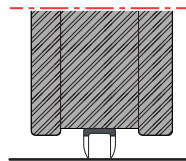

* This type of threshold may be produced from steel or hardwood.

** This type of threshold is fireproof, smoke only S_a



JSC ASMODAS
Skaidrioji str. 22-1
Lithuania, LT 96155 Gargzdai

www.asmodas.eu
export@asmodas.lt
+370 463 427 27

Officiel distributør:



WALLTEC A/S
Nørregade 15, 6622 Bække
Denmark

+45 4698 0808
info@walltec.dk
www.walltec.dk